

《組裝時的注意》

- 組裝前請詳細閱讀說明書。
- 請將零件按編號整齊組裝，組裝後把邊角料丟棄。
- 零配件當中有帶尖銳或刺手的，在組裝時請小心。
- 建議在塗裝粘貼時使用安全的“水性塗料”。

NOTICE WHILE ASSEMBLING

- Please read the instruction carefully before assembly.
- Please assemble the parts as per the serial numbers and discard the leftover material after assembly.
- While assembling, please pay attention that some of the parts may be sharp-pointed or aciculate.
- Please use the soft "aqueous coating" while painting.

 · 黏膠 CLONE	 · 黏膠的編號 NUMBERS ON THE SEALS	 · 黏貼編號 DECAL NUMBER	 · 在物反面之零件 PARTS INSTALLED ON REVERSE SIDE	 · 同時安裝兩側零件 SAME PARTS INSTALLED ON BOTH SIDES	 · 安裝時請注意方向 PAY ATTENTION TO THE DIRECTIONS WHEN INSTALL	 · 注意旋緊螺絲 ATTENTION TO REVOLVE THE SCREW
 · 剪 CUT OFF	 · 配件數量的倍數 QUANTITY OF THE PART	 · 先安裝 EARLIER INSTALL	 · 後安裝 LATER INSTALL	 · 按合時請旋轉 SCREW BASE ON THE WIPK NUMBER	 · 選擇任一方向安裝 CHOOSE ONE SIDE TO INSTALL	 · 在物反面同樣旋轉 SCREW THE SAME ON REVERSE SIDE

配件一覽 PARTS LIST

注意: 印有"x"符號是不需要用的配件
Note: with the "x" symbol is not required to use the accessories

A 配件(FITTINGS)

(ABS樹脂:PS) Polystyrene:PS

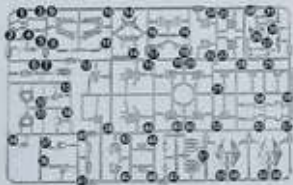

B 配件(FITTINGS)

(聚苯乙烯樹脂:PS) Polystyrene:PS

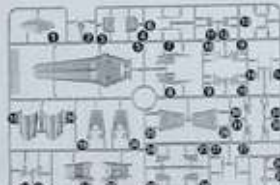

C 配件(FITTINGS)

(聚苯乙烯樹脂:PS) Polystyrene:PS

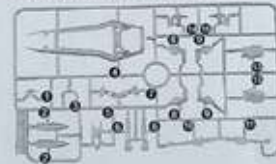

D 配件(FITTINGS)

(聚苯乙烯樹脂:PS) Polystyrene:PS

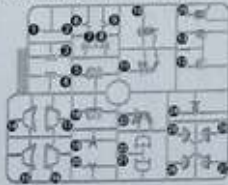

E 配件(FITTINGS)

(ABS樹脂:PS) Polystyrene:PS

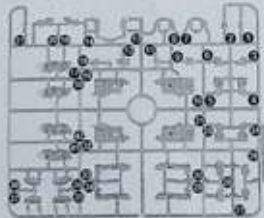

F 配件(FITTINGS)

(聚苯乙烯樹脂:PS) Polystyrene:PS

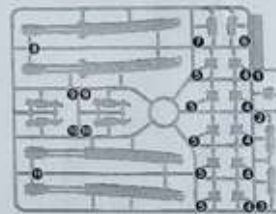

G 配件(FITTINGS)

(聚苯乙烯樹脂:PS) Polystyrene:PS



H 配件(FITTINGS)

(聚苯乙烯樹脂:PS) Polystyrene:PS



I 配件(FITTINGS)

(聚苯乙烯樹脂:PS) Polystyrene:PS



J 配件(FITTINGS)
(ABS樹脂:PS) Polystyrene PS



K 配件(FITTINGS)
(ABS樹脂:PS) Polystyrene PS

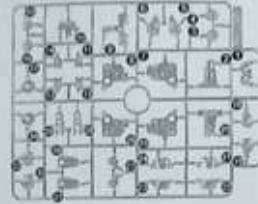

M 配件(FITTINGS)
(聚苯乙烯樹脂:PS) Polystyrene PS



N 配件(FITTINGS)
(ABS樹脂:PS) Polystyrene PS



O 配件(FITTINGS)
(聚苯乙烯樹脂:PS) Polystyrene PS

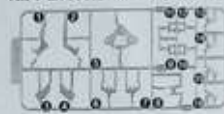

P 配件(FITTINGS)
(聚苯乙烯樹脂:PS) Polystyrene PS

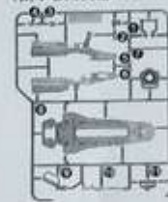

Q 配件(FITTINGS) (x2)
(聚苯乙烯樹脂:PS) Polystyrene PS

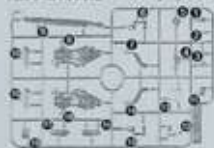

R 配件(FITTINGS)
(ABS樹脂:PS) Polystyrene PS



S 配件(FITTINGS)
(ABS樹脂:PS) Polystyrene PS



T 配件(FITTINGS)
(聚苯乙烯樹脂:PS) Polystyrene PS



U 配件(FITTINGS)
(ABS樹脂:PS) Polystyrene PS

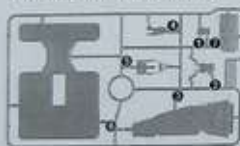

PC 配件(FITTINGS)
(聚苯乙烯樹脂:PS) Polystyrene PS



WF 配件(FITTINGS)
(ABS樹脂:PS) Polystyrene PS

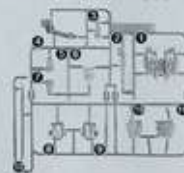

XA 配件(FITTINGS)
(ABS樹脂:PS) Polystyrene PS

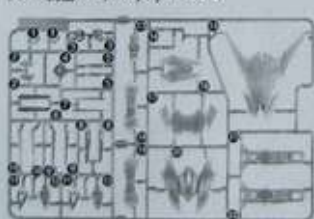

XB 配件(FITTINGS) (x2)
(聚苯乙烯樹脂:PS) Polystyrene PS

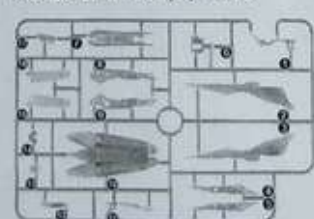

XC 配件(FITTINGS)
(ABS樹脂:PS) Polystyrene PS



XD 配件(FITTINGS)
(ABS树脂:PS) Polystyrene/PS

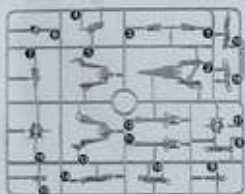

XE 配件(FITTINGS) (x2)
(聚苯乙烯树脂:PS) Polystyrene/PS

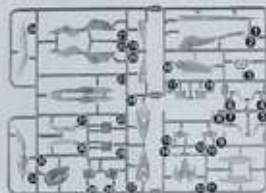

XF 配件(FITTINGS)
(ABS树脂:PS) Polystyrene/PS

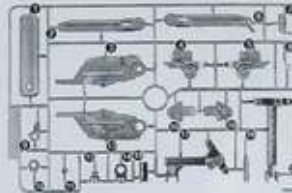

XG 配件(FITTINGS)
(ABS树脂:PS) Polystyrene/PS

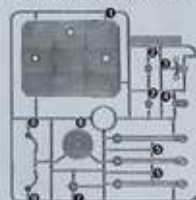

XH 配件(FITTINGS) (x2)
(聚苯乙烯树脂:PS) Polystyrene/PS



螺丝 Screw.....4
螺母 Nut.....4
银色不干胶1张
(Silver glue)
水贴纸1张
(Water Seal)

警告

- 不适合六岁以下儿童使用
- 含有小零件, 请勿吞食, 以免造成窒息危险;
- 内有尖端物小心使用请勿刺人, 以免造成伤害;
- 请在成人指导下正确使用;

产品名称: 战士
型号规格:
执行标准:
适用年龄: 十五岁以上



WARNING:

CHOKING HAZARD-Small parts.
Not for children under 15 years.



1 頭部 HEAD UNIT



• 組裝 **1** 使用的配件 Parts to assemble **1**

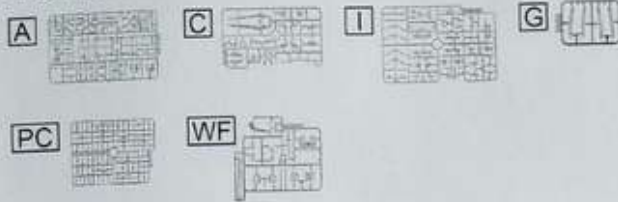

1 頭部的組裝 HEAD UNIT

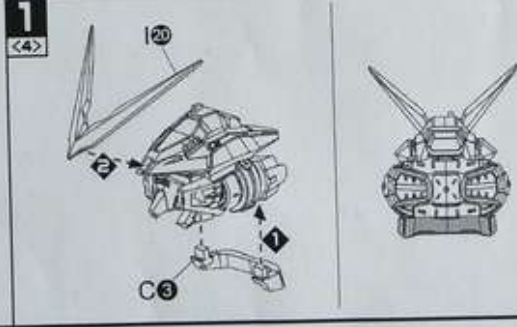
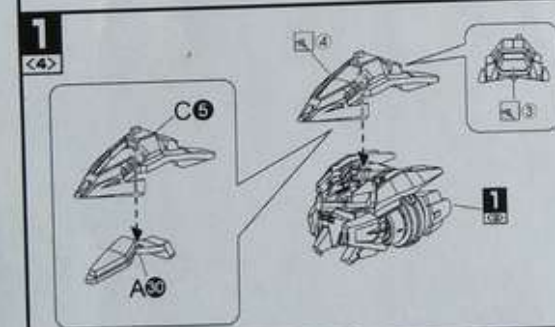
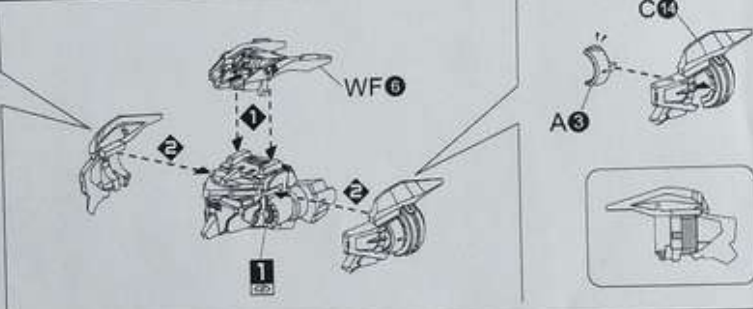
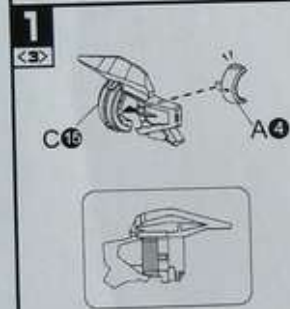
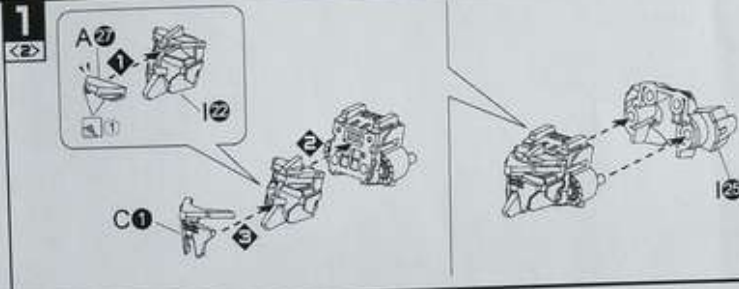
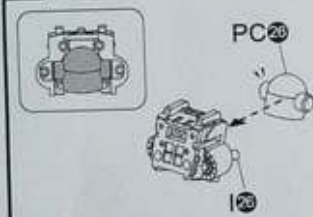

2 胸部 BODY UNIT



• 組裝 **2** 使用的配件 Parts to assemble **2**

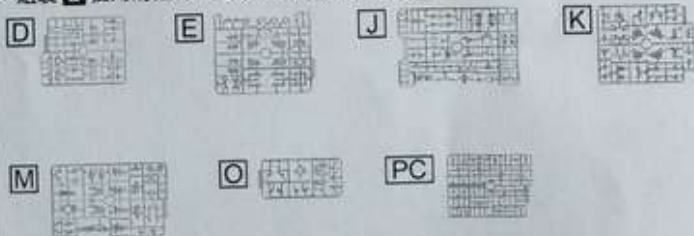

2
<3>

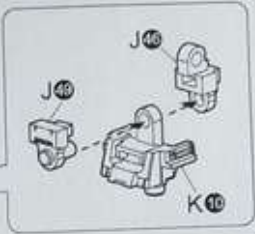
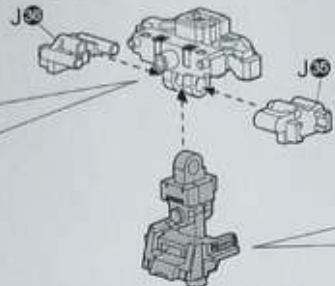
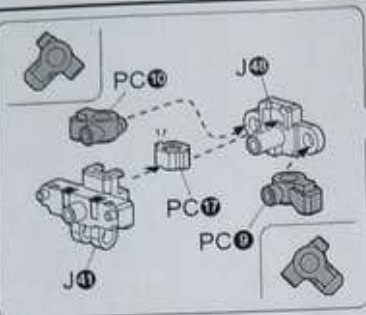

2
<4>

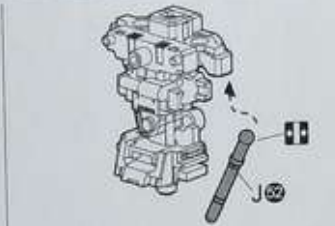
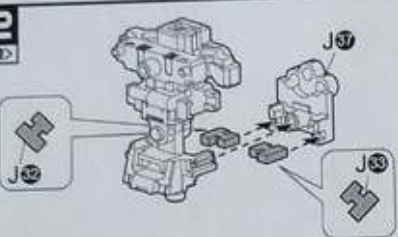

2
<5>

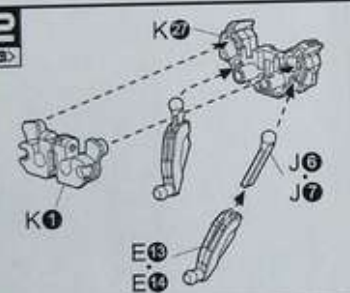

2
<6>

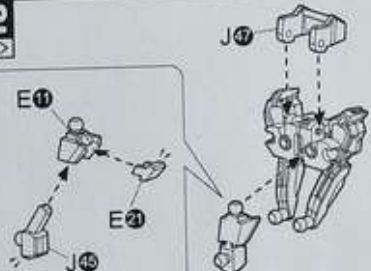

2
<7>

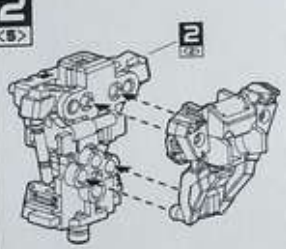

2
<8>

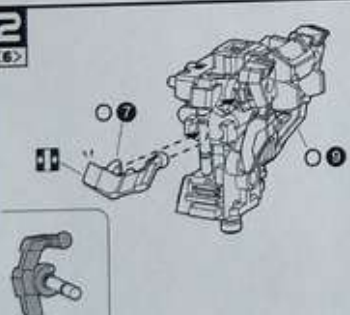

2
<9>

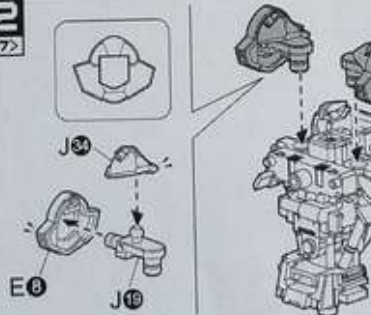

2
<10>

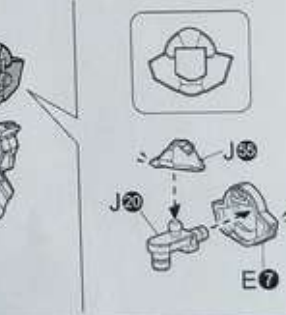

2
<11>

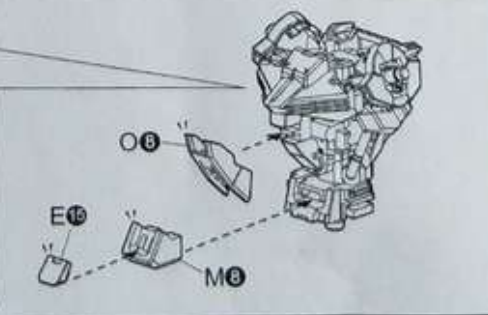
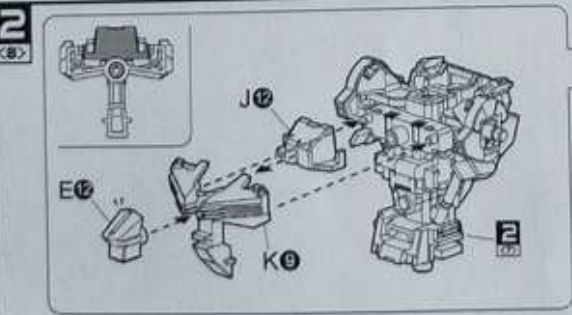

2
<9>

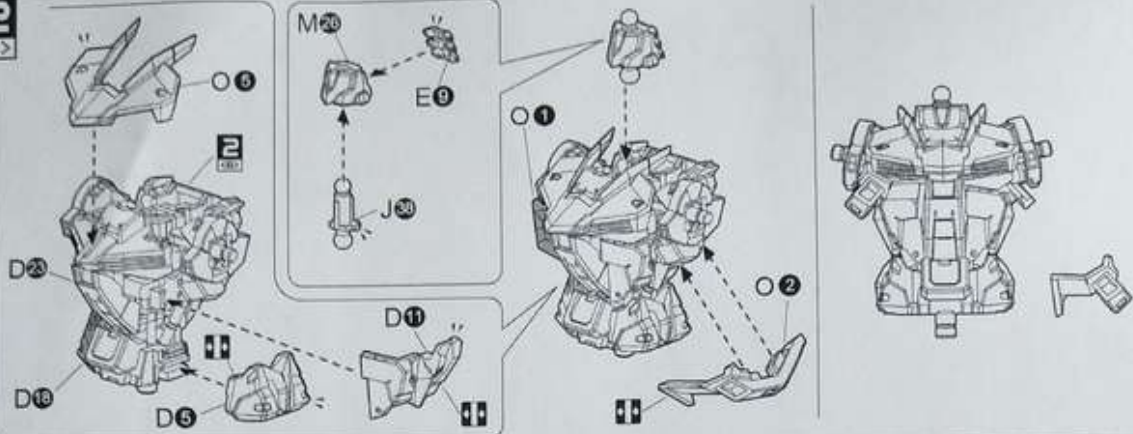

3 4 5 6 手部 ARM UNIT

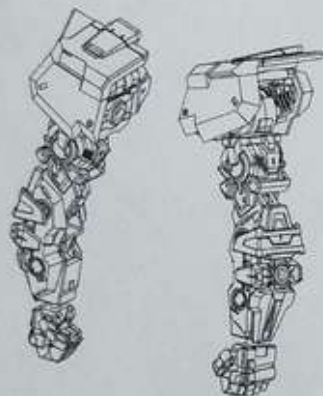

• 組裝 3 4 5 6 使用的配件 Parts to assemble 3 4 5 6

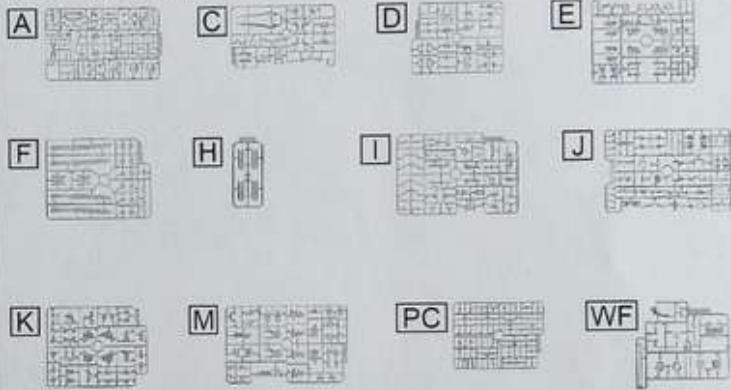

3 左肩部的組裝
LEFT SHOULDER UNIT

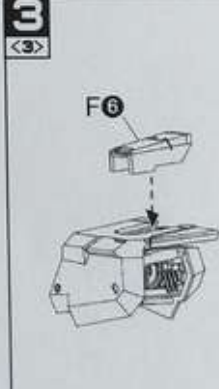
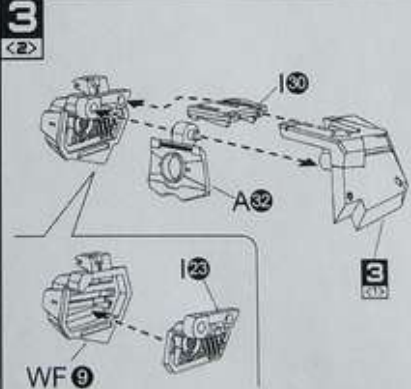
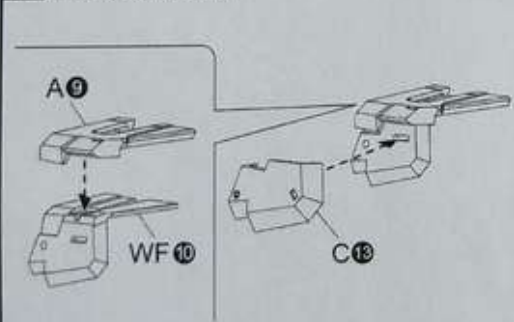

3 左腕部的組裝
LEFT ARM UNIT

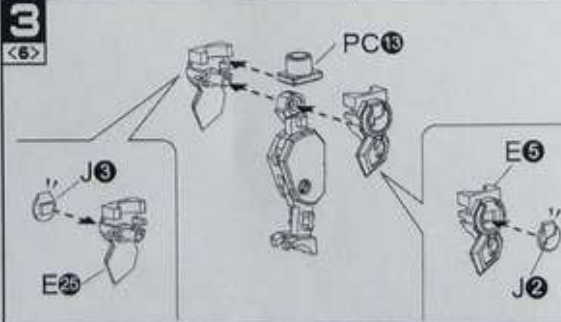
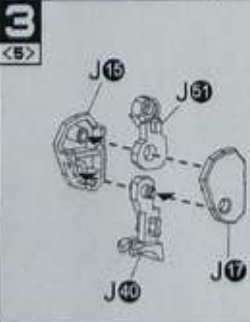
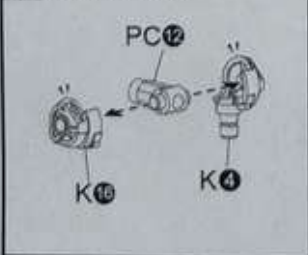

3
<7>

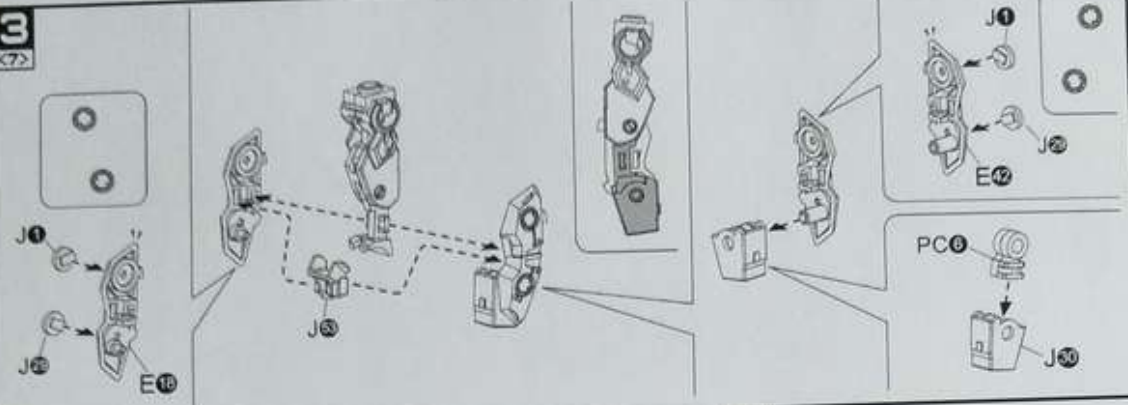

3
<8>

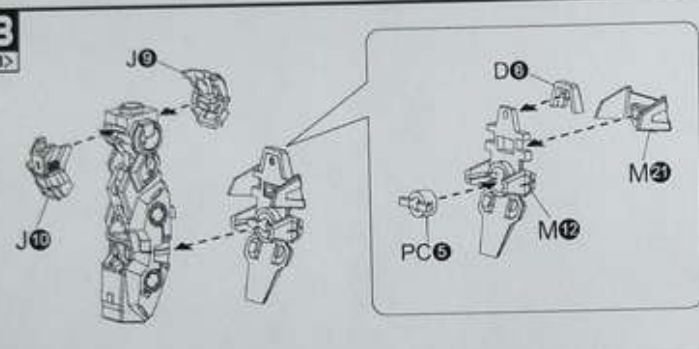

3
<9>

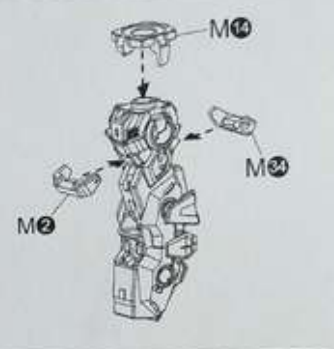

4 左腕的組裝 RIGHT ARM

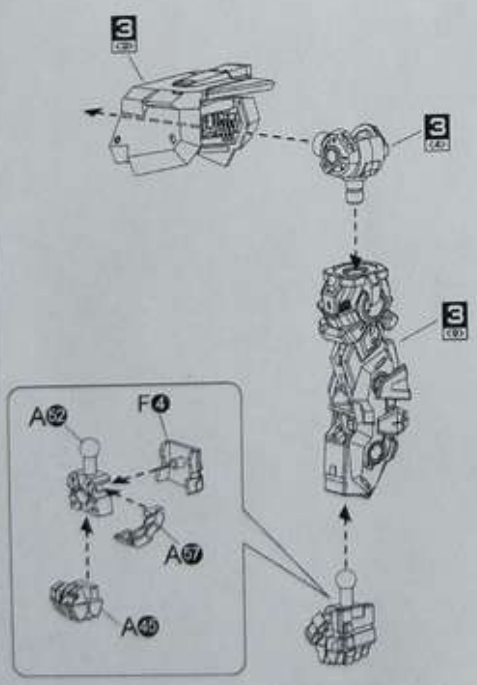

5 右肩部的組裝 RIGHT SHOULDER UNIT

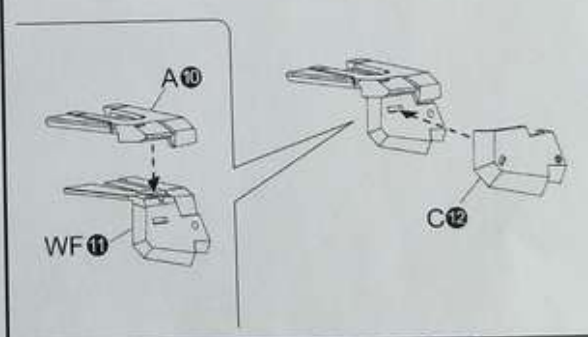

5
<2>

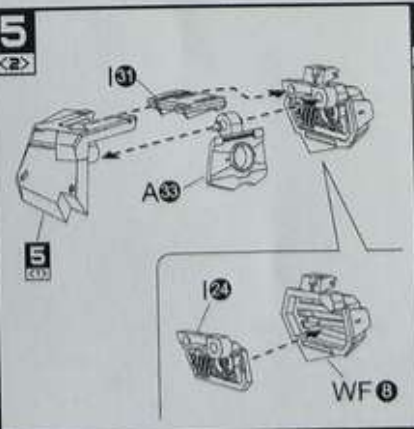

5
<3>



5 右腕部的組裝
RIGHT ARM UNIT

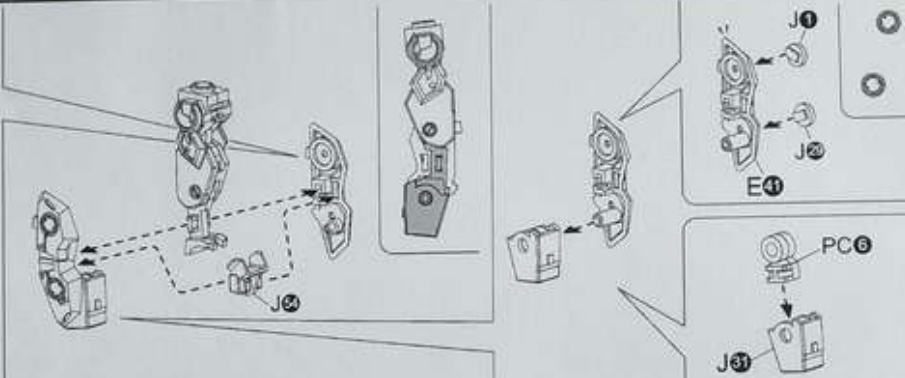
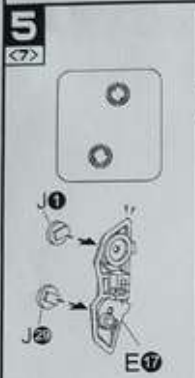
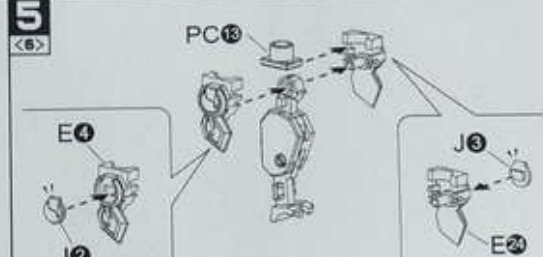
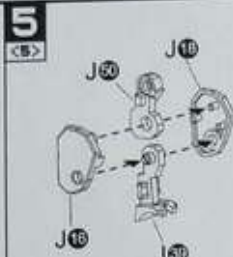
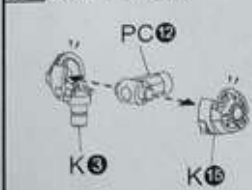

6 右腕的組裝 RIGHT ARM

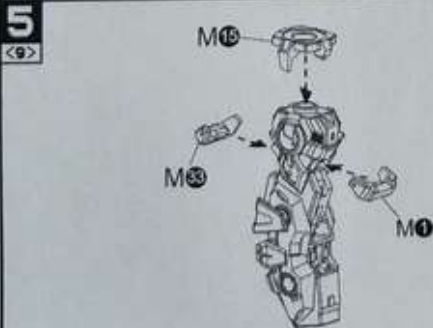
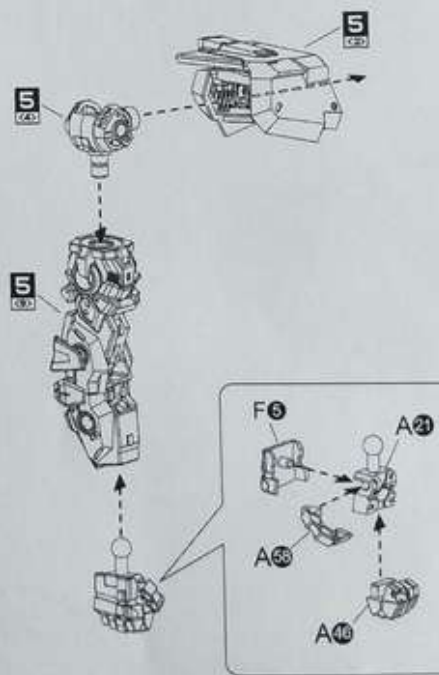

7 上半身完成 UPPER BODY

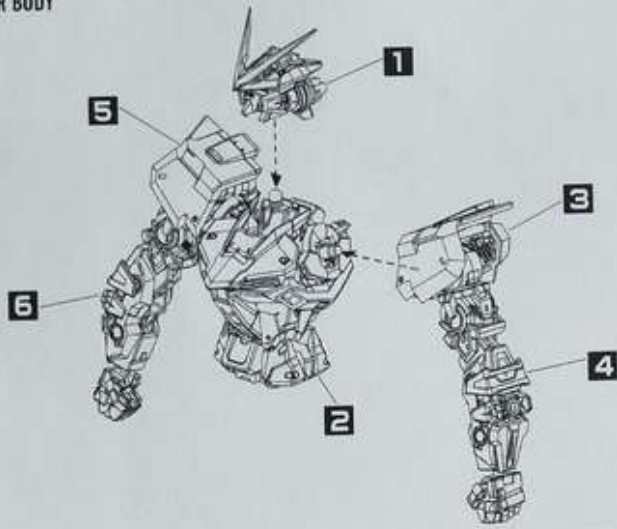

8 腰部組裝 WAIST UNIT

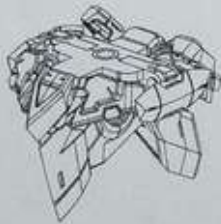

• 組裝 **8** 使用的配件 Parts to assemble **8**

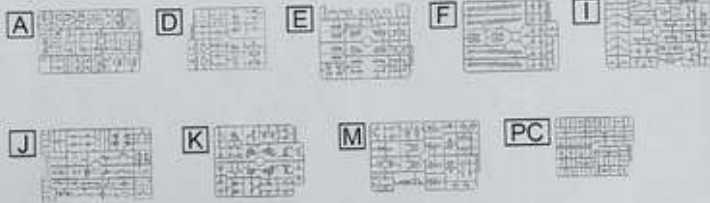

8 腰部的組裝
WAIST UNIT

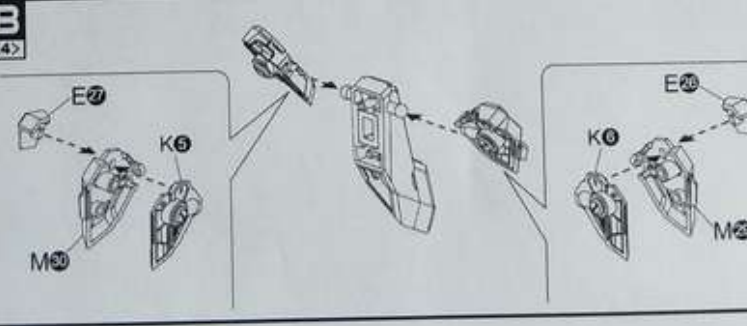
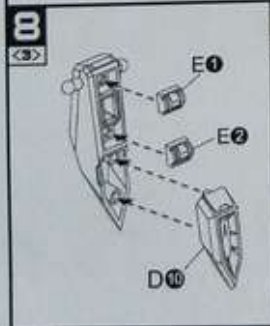
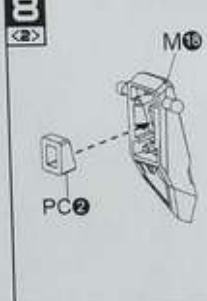
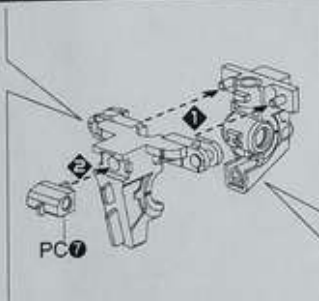
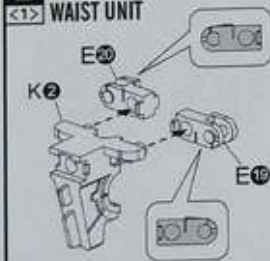

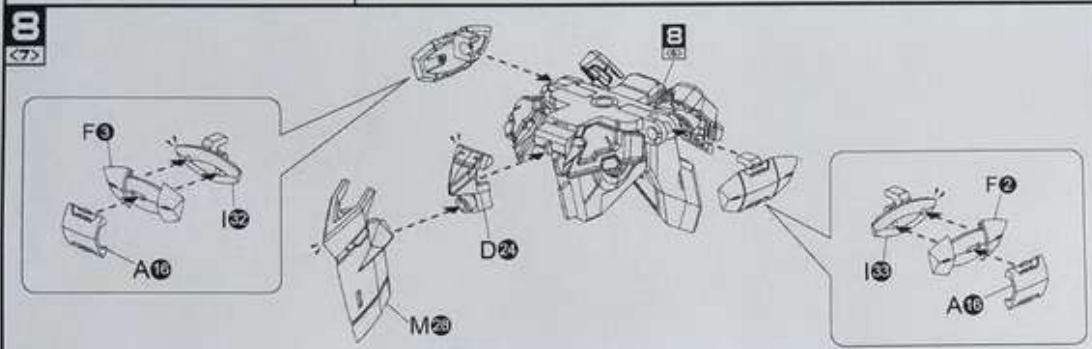
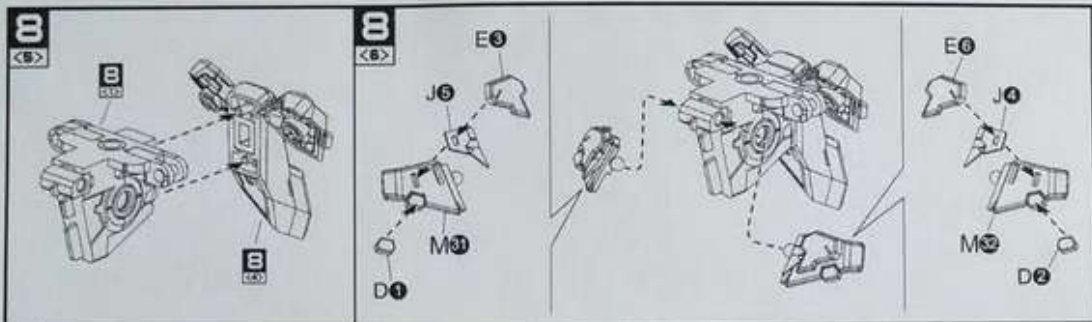

9 10 脚部 LEG UNIT

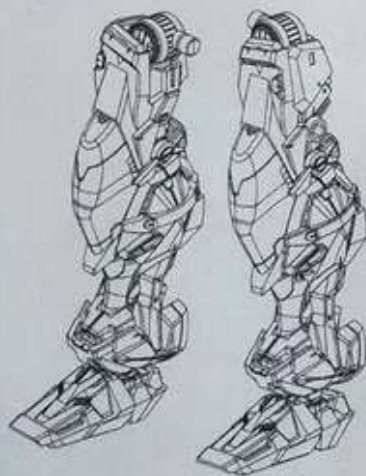

• 組裝 9 10 使用的配件 Parts to assemble 9 10

A	B	C	D
E	I	J	K
M	O	Q (x2)	PC

9 脚部組裝
LEG UNIT

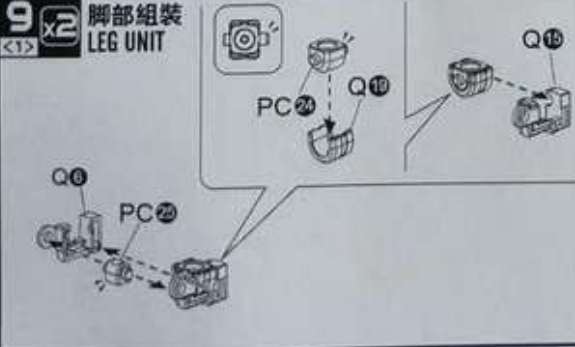

9 右脚組裝
RIGHT LEG

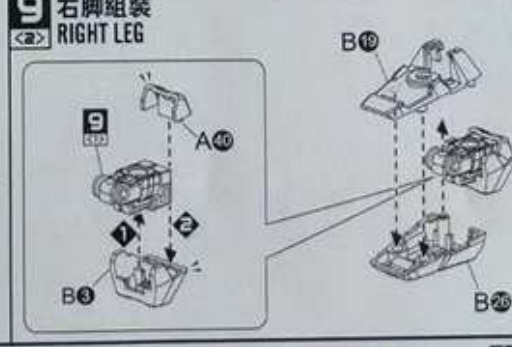

10
<3>

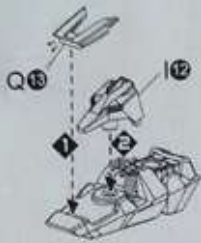

10
<4>

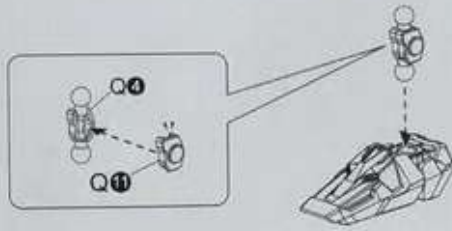

10
<5>

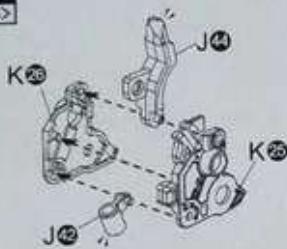

10
<6>

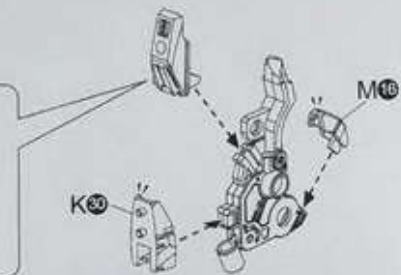

10
<7>

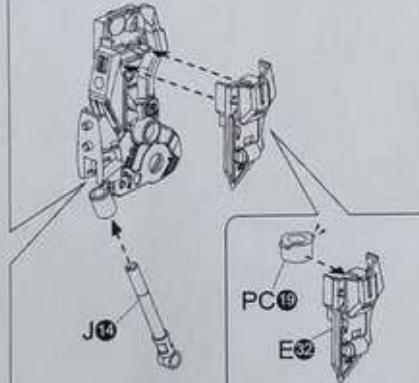
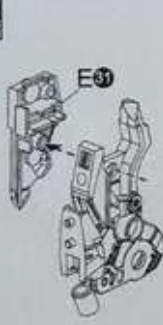

9
<8>

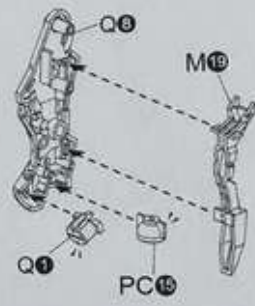

10
<9>

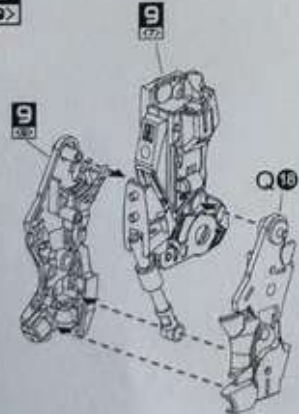

10
<10>

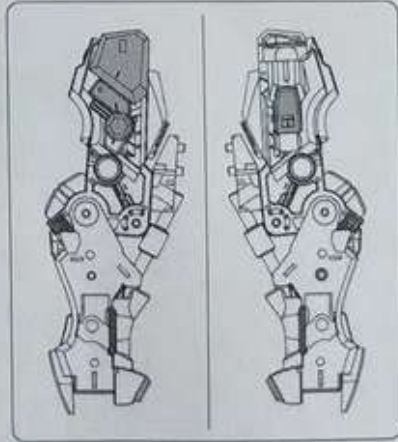
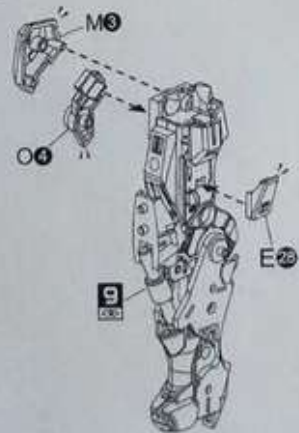

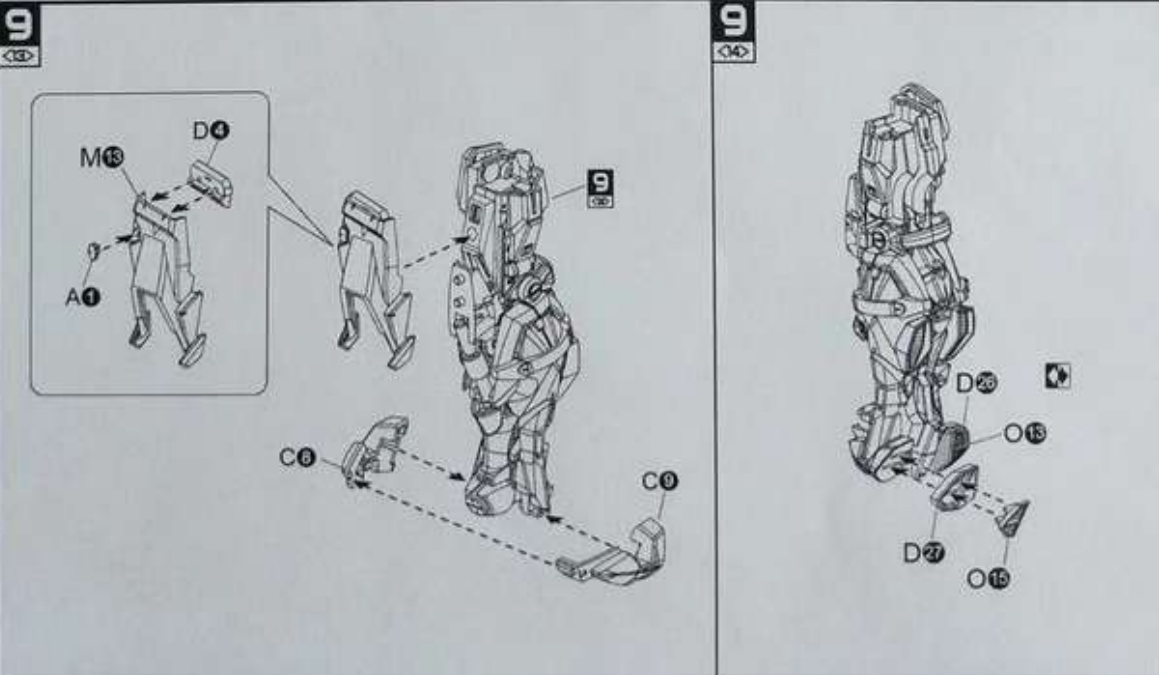
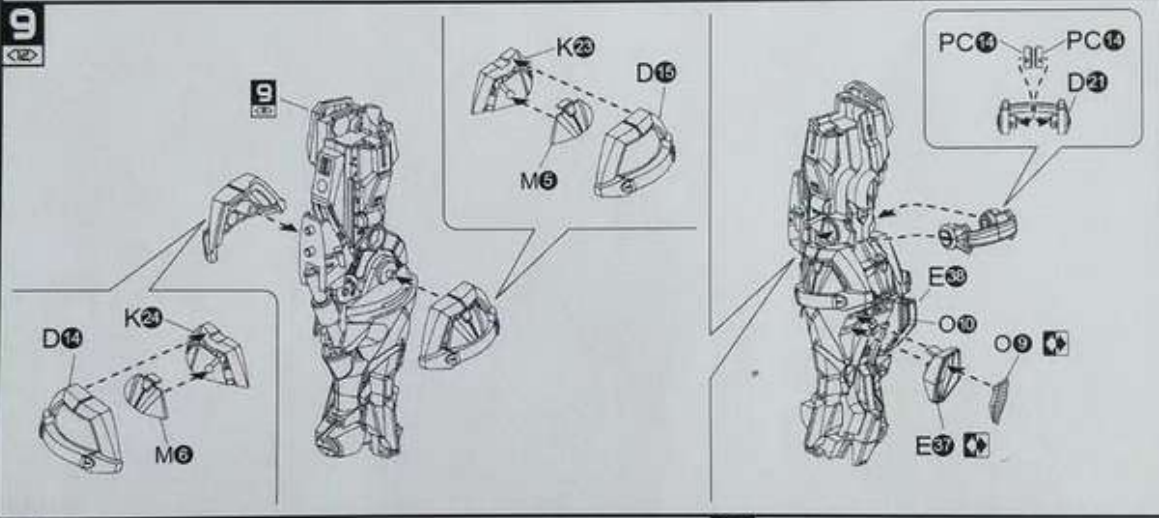
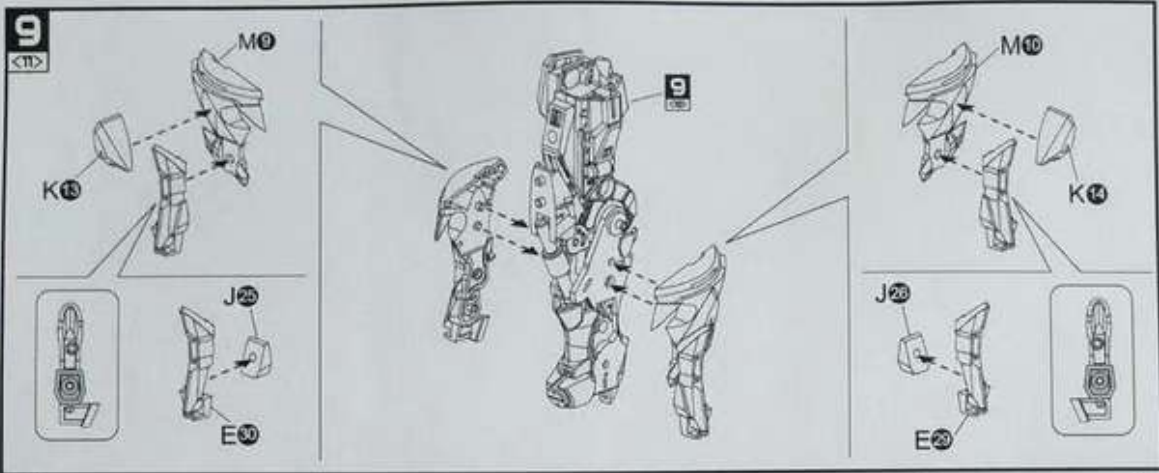

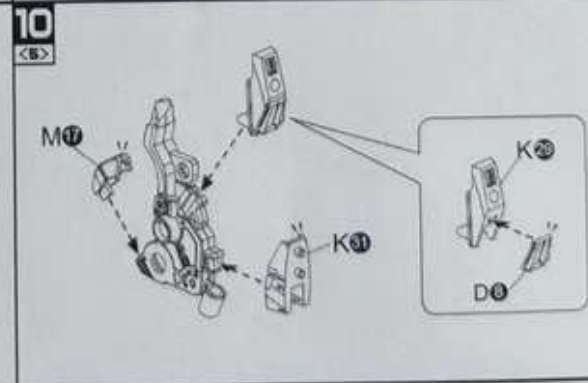
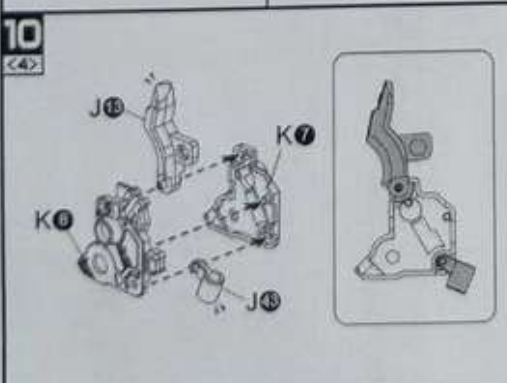
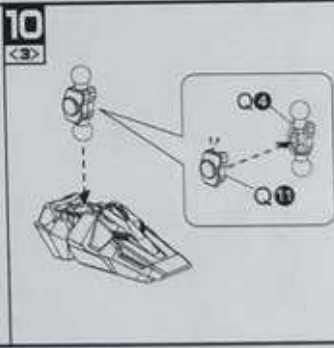
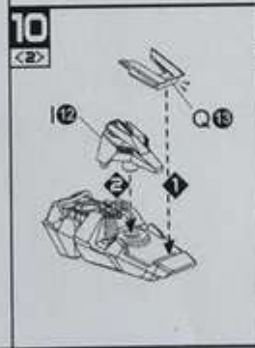
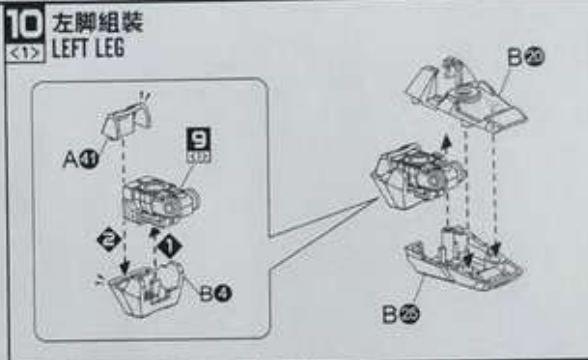
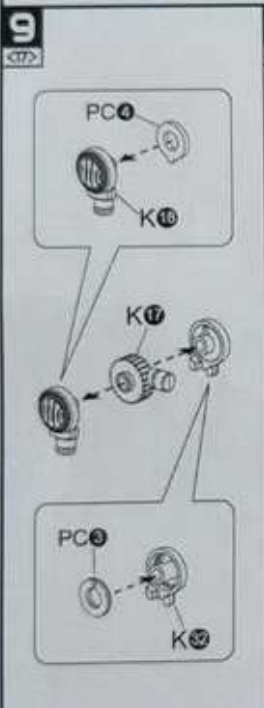
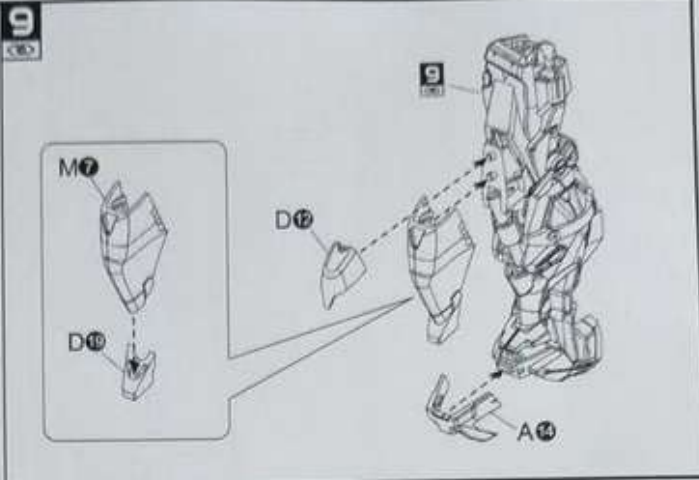
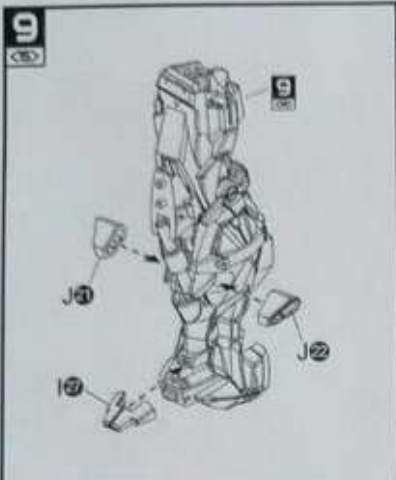

10
<8>

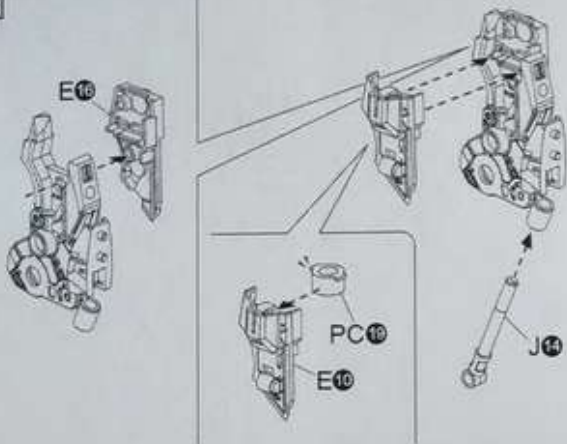

10
<9>

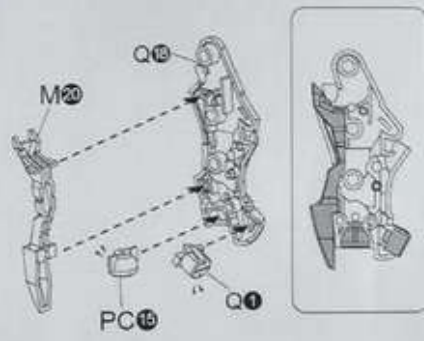

10
<8>

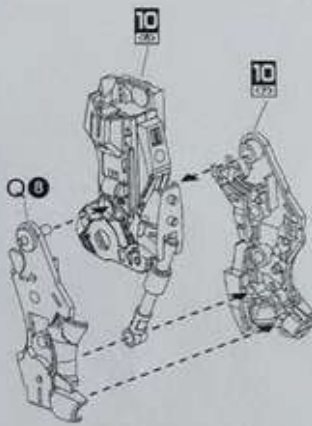

10
<9>

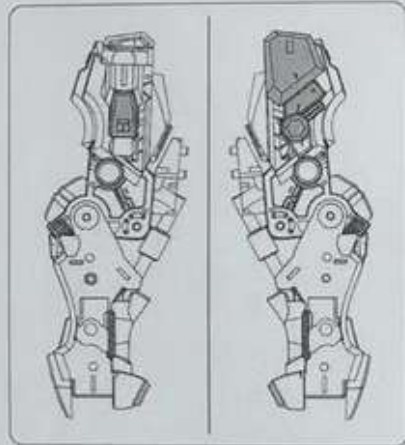
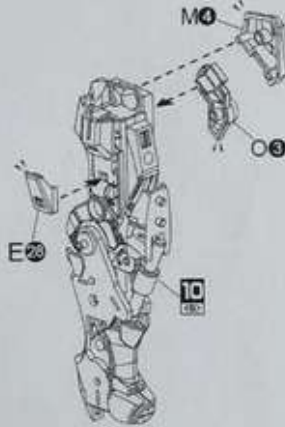

10
<10>

